

Polybin Foundation Recommendations

9' Dia. Polybin Concrete Pad Specs.

	Thickness	Vol. Cu.Yd.
PL-610	10"	4.20
PL-770	11"	4.60
PL-885	12"	5.04

8' Dia. Polybin Concrete Pad Specs.

PL-335	10"	3.40
PL-430	10"	3.40
PL-520	12"	4.10
PL-635	13"	4.35
PL-710	15"	5.20

7' Dia. Polybin Concrete Pad Specs.

PL-140	8"	2.00
PL-235	8"	2.00
PL-300	9"	2.25
PL-365	10"	2.50
PL-420	10"	2.50
PL-460	11"	2.75
PL-480	11"	2.75
PL-525	12"	3.00
PL-645	13"	3.25
PL-705	15"	3.75

5' Dia. Polybin Concrete Pad Specs.

PL- 45	6"	.670
PL- 70	6"	.670
PL- 90	8"	.890
PL- 125	8"	.890

Square Foundation

Round Foundation

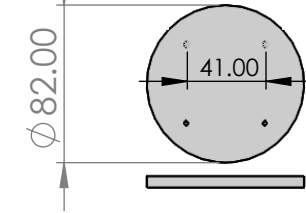
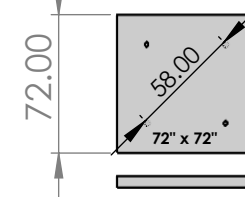
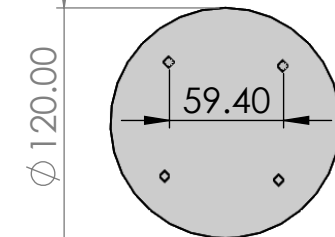
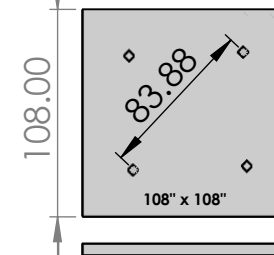
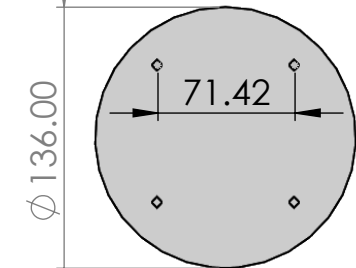
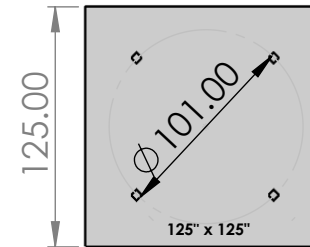
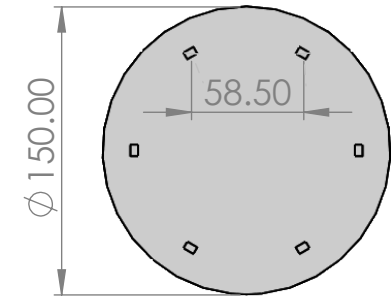
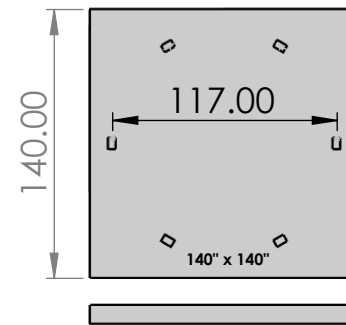

Concrete pad is to be level and have 6 x 6 # 10 WWF (Welded Wire Fabric) at mid thickness point of concrete pad. Use 1/2" or 5/8" proper concrete anchors that extend a minimum of 1" past mid thickness of concrete pad.

NOTE: Leg locations will vary, dimensions should not be used for anchor placement.